

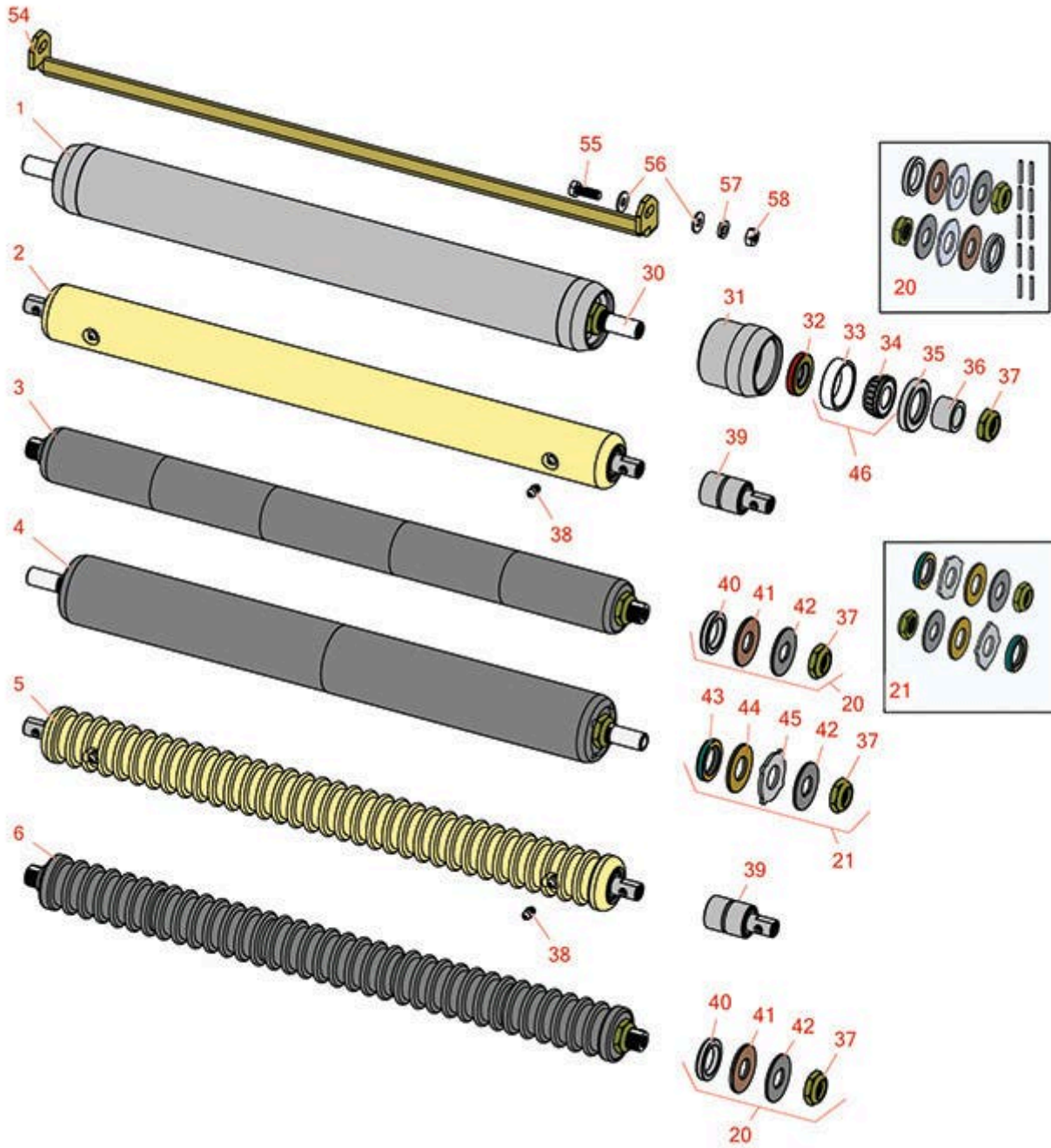

Replaces Jacobsen LF-3400 Parts

5" Reel Units
Rear Rollers



All original equipment manufacturers names and part numbers are used for identification purposes only, and we are in no way implying that our products are original equipment parts. Prices subject to change without notice.



Replaces Jacobsen LF-3400 Parts

5" Reel Units
Rear Rollers



Item No	R&R Part No.	OEM Part No.	Description	Qty Req	Order Quantity
---------	--------------	--------------	-------------	---------	----------------

R&R Rear Rollers

1	R100105	100105, 1002446, 1003728	Roller - Smooth Heavy Duty Tubular Steel	0	
---	----------------	--------------------------------	--	---	--

Tech Note: Constructed with a through shaft, this heavy duty roller uses tapered bearings for extended life. This roller body measures 21" in length.:

2	R68597	68597	Roller - Smooth Solid Steel	0	
---	---------------	-------	-----------------------------	---	--

Tech Note: Machined from solid steel, this heavy weight roller uses greasable "water-pump" style bearings.:

3	R101335		Roller - Smooth UHMW Polyethylene	0	
---	----------------	--	-----------------------------------	---	--

Tech Note: Machined from solid UHMW, this low maintenance roller uses a 1" solid stainless steel shaft and requires no grease. UHMW material prevents build-up of debris.:

4	R1013662		Roller - Smooth UHMW Polyethylene	0	
---	-----------------	--	-----------------------------------	---	--

Tech Note: Machined from solid UHMW, this low maintenance roller uses a 1" solid stainless steel shaft and requires no grease. UHMW material prevents build-up of debris.:

5	R101120	101120, 68580	Roller - Grooved Machined Solid Steel	0	
---	----------------	------------------	---------------------------------------	---	--

Tech Note: Machined from solid steel, this heavy weight roller uses greasable "water-pump" style bearings.:

6	R101337		Roller - Grooved UHMW Polyethylene	0	
---	----------------	--	------------------------------------	---	--

Tech Note: Machined from solid UHMW, this low maintenance roller rotates around a 1" solid stainless steel shaft and requires no bearings or grease. Patented groove design and smooth UHMW material prevents build-up of debris. Shaft length measures 26-3/4".:

Overhaul Kits

20	R101395	100139, 101395	Overhaul Kit - UHMW Roller	1	
----	----------------	-------------------	----------------------------	---	--

Tech Note: Fits all R&R 2" Dia. Black UHMW Polyethylene Rollers. Includes 10 ea.: R150322 Roll Pins; 2 ea.: R3296-15 Locknuts, R150347T Teflon Seals, R150333 Thrust Washers, & R150334A Bronze Thrust Washers:

All original equipment manufacturers names and part numbers are used for identification purposes only, and we are in no way implying that our products are original equipment parts. Prices subject to change without notice.



Replaces Jacobsen LF-3400 Parts

5" Reel Units
Rear Rollers



Item No	R&R Part No.	OEM Part No.	Description	Qty Req	Order Quantity
---------	--------------	--------------	-------------	---------	----------------

21	R101399		Overhaul Kit - UHMW 2 Pc Roller	1	
----	----------------	--	---------------------------------	---	--

Tech Note: Fits all R&R 2-1/2" - 3-1/2" Dia. Black UHMW Plastic Rollers that do not use ball bearings.. Includes 2 ea.: R1503230 Star Washers, R1503470 Seals, R150333 Thrust Washers, R3296-15 Locknuts, R1503471 Bronze Thrust Washers:

Other Parts Available

30	R100106	100106	Shaft - Fits HD Rear Roller	1	
31	R61-0380		Roller End - Cap Solid	2	
32	R253-152	3001656	Seal - Inner Roller	2	
33	R254-79	254-79, 4121175	Cup - Bearing	2	
34	R254-78	254-78, 385174, 4121174, 4135152	Tapered Bearing Cone	2	
35	R253-117	253-117, 3004882	Seal - Outer Triple Lip	2	
36	R150674	150674	Sleeve - Wear 3/4 Plated	2	
37	R3296-15	3296-15, 367029, 444742	Locknut - 3/4-16 Nylon Jam	2	
38	R302-5	302-5, 471214, 471223, 471226	Fitting - Grease	2	
39	R101482	101482	Bearing - Rear Machined Roller	2	
40	R150347T		Seal - Nonstick Lip	2	
41	R150334A		Washer - Thrust SAE660 Bronze	2	
42	R150333		Washer - Flat Keyed Outer SS	2	

All original equipment manufacturers names and part numbers are used for identification purposes only, and we are in no way implying that our products are original equipment parts. Prices subject to change without notice.



Replaces Jacobsen LF-3400 Parts

5" Reel Units

Rear Rollers



Item No	R&R Part No.	OEM Part No.	Description	Qty Req	Order Quantity
43	R1503470		Seal - Inner Wiper	2	
44	R1503471		Washer - Thrust SAE660 Bronze	2	
45	R1503230		Washer - Thrust Outer Keyed	2	
46	R500534	500534, R500534	Bearing - with Cup	2	
54	R338735	338735	Scraper - Rear Roller	1	
55	R400186	400186	Bolt - Hex HD 5/16-18 x 7/8	2	
56	R310266	310266, 452004, 452006, 452008	Washer - Flat 5/16 USS	2	
56	R453009	3256-23, 452004, 452006, 452008, 453009	Washer - Flat 5/16 SAE	0	
57	R446136	446134, 446136	Washer - Lock 5/16 Zinc	2	
58	R443106	443106	Nut - 5/16-18 Y/Zinc Plated	2	

All original equipment manufacturers names and part numbers are used for identification purposes only, and we are in no way implying that our products are original equipment parts. Prices subject to change without notice.