

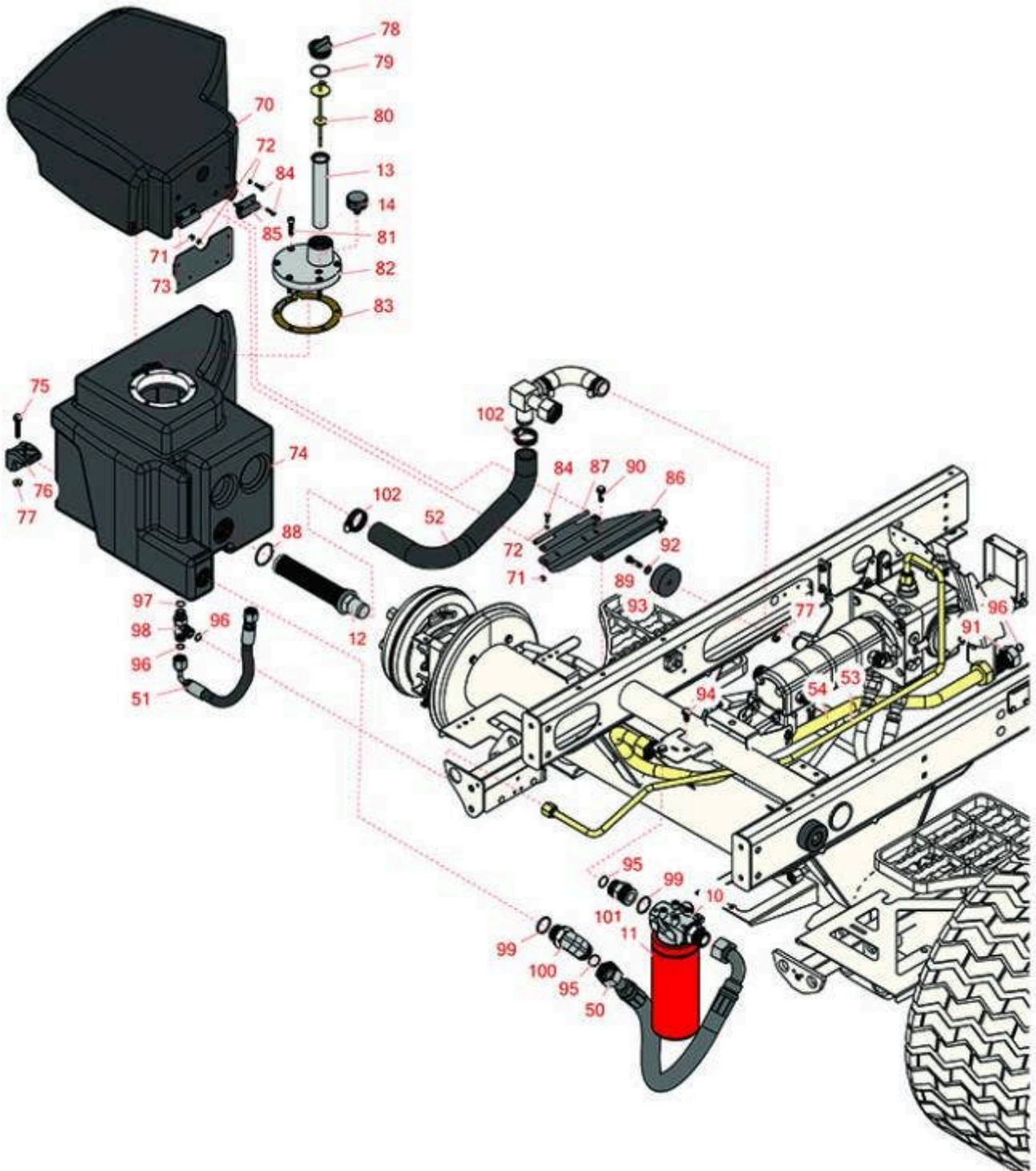

Replaces Toro Reelmaster 5410-D Parts

Traction Unit
Hydraulic Tank



All original equipment manufacturers names and part numbers are used for identification purposes only, and we are in no way implying that our products are original equipment parts. Prices subject to change without notice.



Replaces Toro Reelmaster 5410-D Parts

Traction Unit
Hydraulic Tank



Item No	R&R Part No.	OEM Part No.	Description	Qty Req	Order Quantity
Filters					
10	R104-0080	104-0080	Filter Head Assy w/Filter	1	
10	R92-5821	86-3000, 92-5821	Filter - Head	1	
11	R94-2621	94-2621	Baldwin Oil Filter - Hyd	1	
11	RRF10621		Silverguard Oil Filter - Hyd	1	
12	R105-0131	105-0131	Strainer-Tank - Oil	1	
13	R61-2790	61-2790	Screen - Filler - Hyd Oil	1	
14	R68-6150	58-9070, 68-6150	Breather	1	
Hoses					
50	R108-1689	108-1689	Hydraulic Hose Assy	1	
51	R108-8428	108-8428	Hydraulic Hose Assy	1	
51	R66-8490	66-8490	Hydraulic Hose Assy	1	
52	R108-1685	108-1685	Hose - Formed	1	
53	R110-8915	108-8915, 110-8915	Hydraulic Tube Assy	1	
54	R108-1699	108-1699	Tube Assy	1	
Other Parts Available					
70	R107-4545	107-4545	Cover-Tank	1	
71	R3296-2	32127-10, 3296-2, 9157404	Nut - #10 Lock	8	

All original equipment manufacturers names and part numbers are used for identification purposes only, and we are in no way implying that our products are original equipment parts. Prices subject to change without notice.



Replaces Toro Reelmaster 5410-D Parts

*Traction Unit
Hydraulic Tank*



Item No	R&R Part No.	OEM Part No.	Description	Qty Req	Order Quantity
72	R3256-14	24-7-BD, 32125-2, 3256-14, 3256-51, 51-2170	Washer - 10 Flat	8	
73	R108-1607-03	108-1607-03	Plate-Hinge	1	
74	R107-4513	107-4513	Tank-Oil	1	
75	R94-5780	94-5780	Bolt - 5/16-18 x 1 3/4 Hx Fl	2	
76	R107-4543	107-4543	Clamp	2	
77	R104-8300	104-8300, 104-8300 , 119-4041	Locknut - 5/16-18 Flanged Y/Zinc	3	
78	R93-7498	93-7498	Plug-Oil	1	
79	R237-101	237-101	O-Ring	1	
80	R94-9411	94-9411	Dipstick - Hyd Oil	1	
80	R119-6968	119-6968	Dipstick- Oil	1	
81	R94-3559	94-3559	Screw - Hex Socket Head	6	
82	R108-7641	108-7641	Cap-Tank, Hyd	1	
83	R94-2660	94-2660	Gasket- Hyd Tank	1	
84	R32105-13	32105-13	Screw - Hx Was HD 10-32 x 3/4	8	
85	R110-8925	110-8925	Hinge Assy	2	
86	R108-1606-03	108-1606-03	Bracket-Hinge	1	
87	R110-8928	110-8928	Pin Assy	1	
88	R340-136	340-136	O-Ring	1	

All original equipment manufacturers names and part numbers are used for identification purposes only, and we are in no way implying that our products are original equipment parts. Prices subject to change without notice.



Replaces Toro Reelmaster 5410-D Parts

Traction Unit
Hydraulic Tank



Item No	R&R Part No.	OEM Part No.	Description	Qty Req	Order Quantity
89	R400190	01-150-0720, 01-178-0510, 30-8680, 322-6, 513343	Bolt - Hex HD 5/16-18 x 1-1/4 GR5	1	
90	R3234-29	3234-17, 3234-29	Bolt - 5/16-18x1 Serr Hex	2	
91	R340-128	340-128	Nut-Bulkhead	1	
92	R453009	01-166-0400, 24-10-BD, 24-9-AD, 32-9650, 3256-2, 3256-23, 3256-3, 3256-67, 3290-217, 3556-3, 4-2390, 7-0152	Washer - Flat 5/16 SAE	1	
93	R108-1605	108-1605	Bumper-Recess	1	
94	R3234-1	321-11, 3234-1	Bolt - Flanged Serrated Hex HD 3/8-16 x 3/4	4	
95	R340-65	340-65	O-Ring	4	
96	R237-30	23-6320, 237-30	O-Ring - Seal	3	
97	R237-79	237-79	O-Ring	1	
<i>Tech Note: Fits 2006-2009:</i>					
98	R340-109	340-109	Hydraulic Fitting - Run Tee	1	
<i>Tech Note: Fits 2006-2009:</i>					
99	R237-146	237-146, 340-146	O-Ring	2	

All original equipment manufacturers names and part numbers are used for identification purposes only, and we are in no way implying that our products are original equipment parts. Prices subject to change without notice.



Replaces Toro Reelmaster 5410-D Parts

*Traction Unit
Hydraulic Tank*



Item No	R&R Part No.	OEM Part No.	Description	Qty Req	Order Quantity
100	R340-129	340-129	Hydraulic Fitting - 90 Deg	1	
101	R104-3797	104-3797	Hydraulic Fitting - Striaight	2	
102	R2412-111	2412-111	Clamp - Hose - Worm	2	

All original equipment manufacturers names and part numbers are used for identification purposes only, and we are in no way implying that our products are original equipment parts. Prices subject to change without notice.