

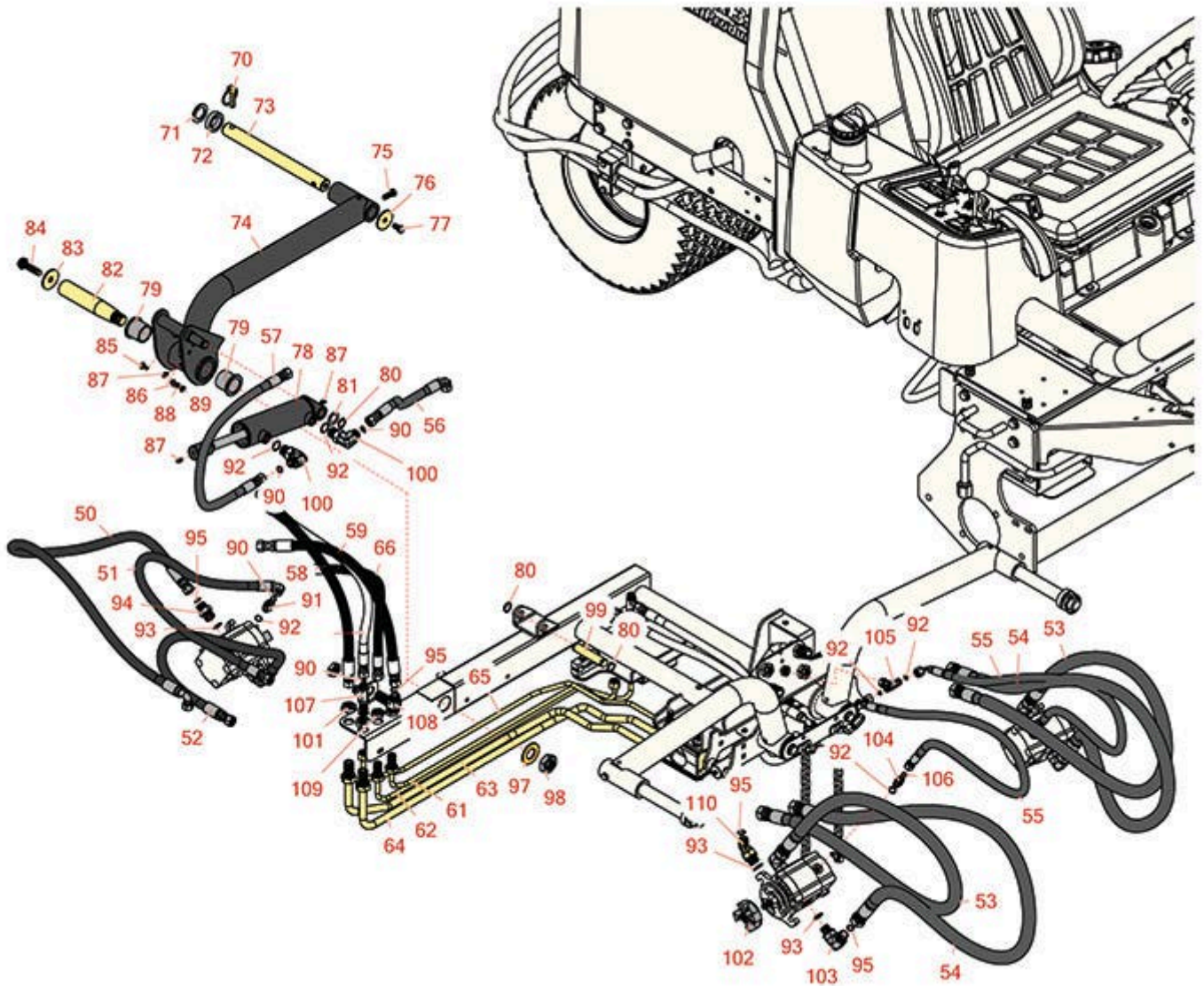

Replaces Toro Reelmaster 3100-D Parts

Traction Unit - Model 03201

Rear Lift Arm & Reel Motors



All original equipment manufacturers names and part numbers are used for identification purposes only, and we are in no way implying that our products are original equipment parts. Prices subject to change without notice.



Replaces Toro Reelmaster 3100-D Parts

Traction Unit - Model 03201

Rear Lift Arm & Reel Motors



Item No	R&R Part No.	OEM Part No.	Description	Qty Req	Order Quantity
Hoses					
50	R95-8826	95-8826	Hydraulic Hose Assy	1	
51	R95-8828	95-8828	Hydraulic Hose Assy	1	
52	R95-8827	95-8827	Hydraulic Hose Assy	1	
53	R95-8835	95-8835	Hydraulic Hose Assy	2	
54	R95-8836	95-8836	Hydraulic Hose Assy	2	
55	R95-8837	105-4348, 95-8837	Hydraulic Hose Assy	2	
56	R95-8831	95-8831	Hydraulic Hose Assy	1	
57	R99-3576	99-3576	Hydraulic Hose Assy	1	
58	R99-3574	99-3574	Hydraulic Hose Assy	1	
59	R99-3578	99-3578	Hydraulic Hose Assy	1	
61	R95-8984	95-8984	Tube Assy	1	
62	R95-8983	95-8983	Tube Assy	1	
63	R95-8980	95-8980	Tube Assy	1	
64	R95-8981	95-8981	Tube Assy	1	
65	R95-8982	95-8982	Tube Assy	1	
66	R99-3579	99-3579	Hydraulic Hose Assy	1	
Other Parts Available					
70	R283-71	283-71	Pin - Lynch Heavy Duty	3	
71	R3-6781	3-6781	Washer - Thrust - Castor Wheel	3	
72	R63-0070	26-1580, 63-0070	Spacer - 1/2 HOC	3	

All original equipment manufacturers names and part numbers are used for identification purposes only, and we are in no way implying that our products are original equipment parts. Prices subject to change without notice.



Replaces Toro Reelmaster 3100-D Parts

Traction Unit - Model 03201

Rear Lift Arm & Reel Motors



Item No	R&R Part No.	OEM Part No.	Description	Qty Req	Order Quantity
73	R104-1392	104-1392	Shaft-Pivot	1	
74	R115-3475	115-3475, 95-8985	Lift Arm Assy - Rear	1	
78	R323-6	01-150-0010, 01-178-0608, 20-47-AD, 20-47-AGD, 3224-2, 323-6, 49-3510, 908034P, 908332	Bolt - Hex HD 3/8-16 x 1 GR5 YZ	1	
76	R63-7400	63-7400	Washer - Rebound	1	
77	R101526	01-150-0970, 01-178-0620, 101526, 20-53-AGD, 321-11, 3224-8, 323-11, 323-12, 323-31, 323-4, 323-47	Bolt - Hex HD 3/8-16 x 2-1/2 GR5	1	
78	R112-9916	108-9033, 112-9916	Hydraulic Cylinder	1	
78	R95-8978	95-8978	Hydraulic Cylinder	1	
79	R69-6470	69-6470	Bushing - Flanged	2	
80	R32120-93	32120-93	Snap Ring - HD	3	
81	R3-6498	3--6498, 3-6498, 47-8270	Washer - Thrust	1	
82	R95-8990	95-8990	Shaft - Pivot - Rear	1	
83	R75-7730	75-7730	Washer - Thrust	1	

All original equipment manufacturers names and part numbers are used for identification purposes only, and we are in no way implying that our products are original equipment parts. Prices subject to change without notice.



Replaces Toro Reelmaster 3100-D Parts

Traction Unit - Model 03201

Rear Lift Arm & Reel Motors



Item No	R&R Part No.	OEM Part No.	Description	Qty Req	Order Quantity
84	R3234-27	3234-27	Bolt - 1/2-13 x 2 Hex	1	
85	R3229-1	01-173-0406, 01-178-0408, 3229-1, 3229-25, 900015P	Bolt - 1/4-20 x 3/4 - Carriage	1	
86	R3256-22	24-9-BD, 3-1032, 3256-1, 3256-22, 93-0954, 93-0989	Washer - Flat 1/4 Yellow	1	
87	R302-5	21-6010, 302-11, 302-37, 302-47, 302-5, 302-57, 302-58, 302-6, 31-0300, 32-9660, 60-0800, 62-3880, 92-4181	Fitting - Grease	1	
88	R3253-3	01-166-0070, 01-166-0410, 23-9-GD, 24-7150, 3253-3, 3256-1, 352-167	Washer - Lock 1/4	1	
89	R443102	01-188-0420, 22-11-AJD, 3217-5, 33024-00	Nut - 1/4-20 Yellow Zinc	1	
90	R237-22	107-8844, 237-22, 237-78	O-Ring	1	

All original equipment manufacturers names and part numbers are used for identification purposes only, and we are in no way implying that our products are original equipment parts. Prices subject to change without notice.



Replaces Toro Reelmaster 3100-D Parts

Traction Unit - Model 03201

Rear Lift Arm & Reel Motors



Item No	R&R Part No.	OEM Part No.	Description	Qty Req	Order Quantity
91	R340-2	340-2, 60-1920	Hydraulic Fitting - Striaight	1	
92	R237-42	237-42, 31-4160	O-Ring	1	
93	R237-80	237-80, 327-80	O-Ring	2	
94	R340-6	340-6	Hydraulic Fitting - Straight	2	
95	R237-30	23-6320, 237-30	O-Ring - Seal	2	
97	R86-1480	86-1480	Washer - 1 3/4 x 1 x 3/16	1	
98	R3220-9	3220-9	Nut-Jam	1	
99	R95-8575	95-8575	Pin	1	
100	R340-77	340-100, 340-77, 95-7889	Hydraulic Fitting	2	
101	R340-127	340-127	Nut - Bulkhead	2	
102	R93-8823	93-8823	Coupling - Motor End	3	
103	R340-105	340-105	Hydraulic Fitting	4	
104	R340-1	340-1, 88-1380	Hydraulic Fitting	2	
105	R99-3477	99-3477	Fitting-Tee	1	
106	R237-21	237-21, 327-21	O-Ring	2	
107	R340-68	340-120, 340-68	Fitting - Tee - Bulkhead	2	
108	R93-9151	93-9151	Hydraulic Fitting	1	
109	R340-70	340-70	Nut - Lock	2	

All original equipment manufacturers names and part numbers are used for identification purposes only, and we are in no way implying that our products are original equipment parts. Prices subject to change without notice.



Replaces Toro Reelmaster 3100-D Parts

Traction Unit - Model 03201

Rear Lift Arm & Reel Motors



Item No	R&R Part No.	OEM Part No.	Description	Qty Req	Order Quantity
110	R340-89	340-89	Hydraulic Fitting - 45 Deg	1	

All original equipment manufacturers names and part numbers are used for identification purposes only, and we are in no way implying that our products are original equipment parts. Prices subject to change without notice.