

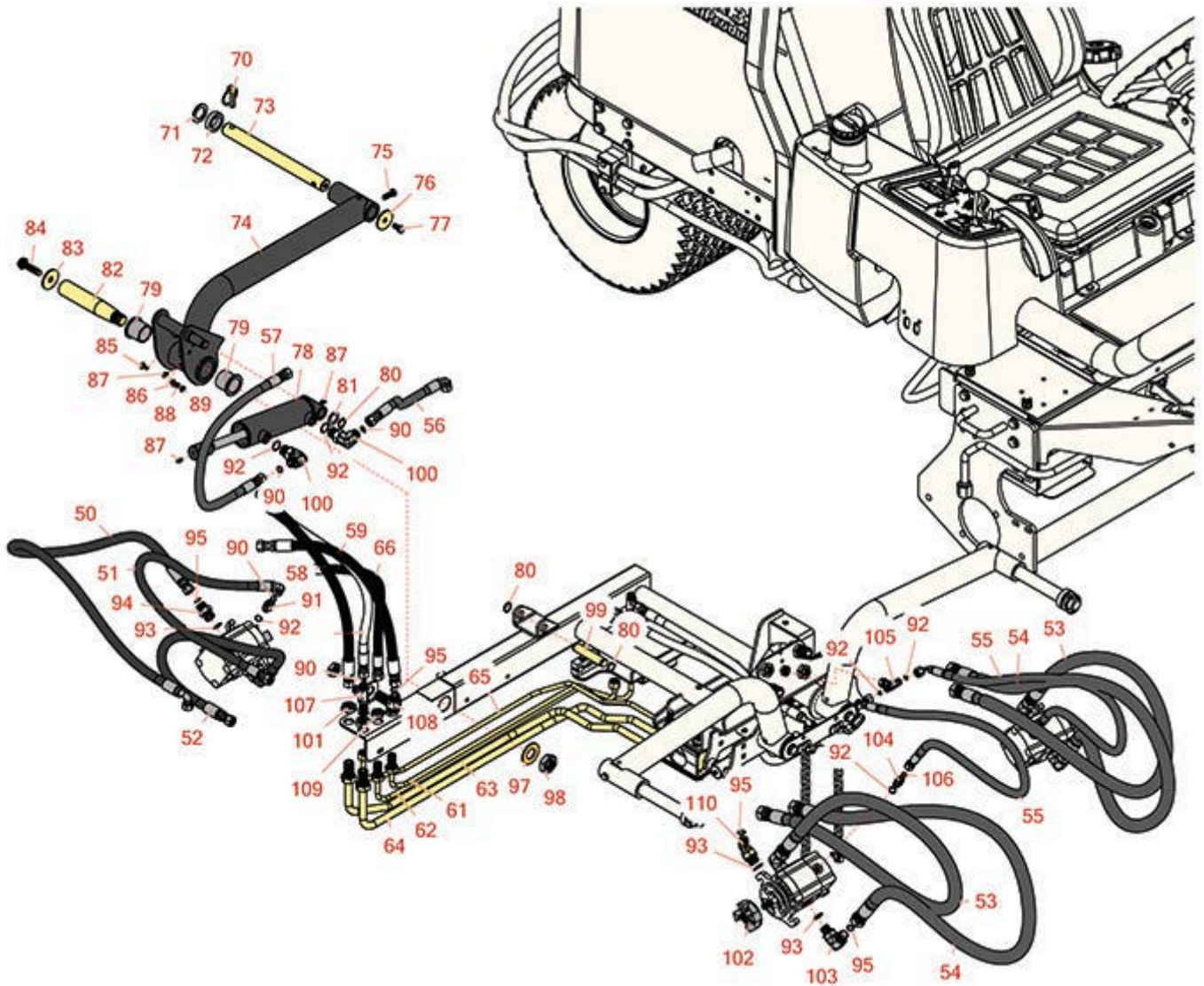

# Replaces Toro Reelmaster 3100-D Parts

*Traction Unit - Model 03200*

*Rear Lift Arm & Reel Motors*



All original equipment manufacturers names and part numbers are used for identification purposes only, and we are in no way implying that our products are original equipment parts. Prices subject to change without notice.



# Replaces Toro Reelmaster 3100-D Parts

Traction Unit - Model 03200

Rear Lift Arm & Reel Motors



Item No	R&R Part No.	OEM Part No.	Description	Qty Req	Order Quantity
<b>Hoses</b>					
50	<b>R95-8826</b>	95-8826	Hydraulic Hose Assy	1	
51	<b>R95-8828</b>	95-8828	Hydraulic Hose Assy	1	
52	<b>R95-8827</b>	95-8827	Hydraulic Hose Assy	1	
53	<b>R95-8835</b>	95-8835	Hydraulic Hose Assy	2	
54	<b>R95-8836</b>	95-8836	Hydraulic Hose Assy	2	
55	<b>R95-8837</b>	105-4348, 95-8837	Hydraulic Hose Assy	2	
56	<b>R95-8831</b>	95-8831	Hydraulic Hose Assy	1	
57	<b>R99-3576</b>	99-3576	Hydraulic Hose Assy	1	
58	<b>R99-3574</b>	99-3574	Hydraulic Hose Assy	1	
59	<b>R99-3578</b>	99-3578	Hydraulic Hose Assy	1	
61	<b>R95-8984</b>	95-8984	Tube Assy	1	
62	<b>R95-8983</b>	95-8983	Tube Assy	1	
63	<b>R95-8980</b>	95-8980	Tube Assy	1	
64	<b>R95-8981</b>	95-8981	Tube Assy	1	
65	<b>R95-8982</b>	95-8982	Tube Assy	1	
66	<b>R99-3579</b>	99-3579	Hydraulic Hose Assy	1	
<b>Other Parts Available</b>					
70	<b>R283-71</b>	283-71	Pin - Lynch Heavy Duty	3	
71	<b>R3-6781</b>	3-6781	Washer - Thrust - Castor Wheel	3	
72	<b>R63-0070</b>	26-1580, 63-0070	Spacer - 1/2 HOC	3	

All original equipment manufacturers names and part numbers are used for identification purposes only, and we are in no way implying that our products are original equipment parts. Prices subject to change without notice.



# Replaces Toro Reelmaster 3100-D Parts

*Traction Unit - Model 03200*

*Rear Lift Arm & Reel Motors*



Item No	R&R Part No.	OEM Part No.	Description	Qty Req	Order Quantity
73	<b>R104-1392</b>	104-1392	Shaft-Pivot	1	
74	<b>R115-3475</b>	115-3475, 95-8985	Lift Arm Assy - Rear	1	
78	<b>R323-6</b>	01-150-0010, 01-178-0608, 20-47-AD, 20-47-AGD, 3224-2, 323-6, 49-3510, 908034P, 908332	Bolt - Hex HD 3/8-16 x 1 GR5 YZ	1	
76	<b>R63-7400</b>	63-7400	Washer - Rebound	1	
77	<b>R101526</b>	01-150-0970, 01-178-0620, 101526, 20-53-AGD, 321-11, 3224-8, 323-11, 323-12, 323-31, 323-4, 323-47	Bolt - Hex HD 3/8-16 x 2-1/2 GR5	1	
78	<b>R112-9916</b>	108-9033, 112-9916	Hydraulic Cylinder	1	
78	<b>R95-8978</b>	95-8978	Hydraulic Cylinder	1	
79	<b>R69-6470</b>	69-6470	Bushing - Flanged	2	
80	<b>R32120-93</b>	32120-93	Snap Ring - HD	3	
81	<b>R3-6498</b>	3--6498, 3-6498, 47-8270	Washer - Thrust	1	
82	<b>R95-8990</b>	95-8990	Shaft - Pivot - Rear	1	
83	<b>R75-7730</b>	75-7730	Washer - Thrust	1	

All original equipment manufacturers names and part numbers are used for identification purposes only, and we are in no way implying that our products are original equipment parts. Prices subject to change without notice.



# Replaces Toro Reelmaster 3100-D Parts

*Traction Unit - Model 03200*

*Rear Lift Arm & Reel Motors*



Item No	R&R Part No.	OEM Part No.	Description	Qty Req	Order Quantity
84	<b>R3234-27</b>	3234-27	Bolt - 1/2-13 x 2 Hex	1	
85	<b>R3229-1</b>	01-173-0406, 01-178-0408, 3229-1, 3229-25, 900015P	Bolt - 1/4-20 x 3/4 - Carriage	1	
86	<b>R3256-22</b>	24-9-BD, 3-1032, 3256-1, 3256-22, 93-0954, 93-0989	Washer - Flat 1/4 Yellow	1	
87	<b>R302-5</b>	21-6010, 302-11, 302-37, 302-47, 302-5, 302-57, 302-58, 302-6, 31-0300, 32-9660, 60-0800, 62-3880, 92-4181	Fitting - Grease	1	
88	<b>R3253-3</b>	01-166-0070, 01-166-0410, 23-9-GD, 24-7150, 3253-3, 3256-1, 352-167	Washer - Lock 1/4	1	
89	<b>R443102</b>	01-188-0420, 22-11-AJD, 3217-5, 33024-00	Nut - 1/4-20 Yellow Zinc	1	
90	<b>R237-22</b>	107-8844, 237-22, 237-78	O-Ring	1	

All original equipment manufacturers names and part numbers are used for identification purposes only, and we are in no way implying that our products are original equipment parts. Prices subject to change without notice.



# Replaces Toro Reelmaster 3100-D Parts

*Traction Unit - Model 03200*

*Rear Lift Arm & Reel Motors*



Item No	R&R Part No.	OEM Part No.	Description	Qty Req	Order Quantity
91	<b>R340-2</b>	340-2, 60-1920	Hydraulic Fitting - Striaight	1	
92	<b>R237-42</b>	237-42, 31-4160	O-Ring	1	
93	<b>R237-80</b>	237-80, 327-80	O-Ring	2	
94	<b>R340-6</b>	340-6	Hydraulic Fitting - Straight	2	
95	<b>R237-30</b>	23-6320, 237-30	O-Ring - Seal	2	
97	<b>R86-1480</b>	86-1480	Washer - 1 3/4 x 1 x 3/16	1	
98	<b>R3220-9</b>	3220-9	Nut-Jam	1	
99	<b>R95-8575</b>	95-8575	Pin	1	
100	<b>R340-77</b>	340-100, 340-77, 95-7889	Hydraulic Fitting	2	
101	<b>R340-127</b>	340-127	Nut - Bulkhead	2	
102	<b>R93-8823</b>	93-8823	Coupling - Motor End	3	
103	<b>R340-105</b>	340-105	Hydraulic Fitting	4	
104	<b>R340-1</b>	340-1, 88-1380	Hydraulic Fitting	2	
105	<b>R99-3477</b>	99-3477	Fitting-Tee	1	
106	<b>R237-21</b>	237-21, 327-21	O-Ring	2	
107	<b>R340-68</b>	340-120, 340-68	Fitting - Tee - Bulkhead	2	
108	<b>R93-9151</b>	93-9151	Hydraulic Fitting	1	
109	<b>R340-70</b>	340-70	Nut - Lock	2	

All original equipment manufacturers names and part numbers are used for identification purposes only, and we are in no way implying that our products are original equipment parts. Prices subject to change without notice.



# Replaces Toro Reelmaster 3100-D Parts

*Traction Unit - Model 03200*

*Rear Lift Arm & Reel Motors*



Item No	R&R Part No.	OEM Part No.	Description	Qty Req	Order Quantity
110	<b>R340-89</b>	340-89	Hydraulic Fitting - 45 Deg	1	

All original equipment manufacturers names and part numbers are used for identification purposes only, and we are in no way implying that our products are original equipment parts. Prices subject to change without notice.