



Replaces John Deere 3225B Reel Mower

Parts

Medium Verti-Cut Unit

Verti-Cut Reel & Frame

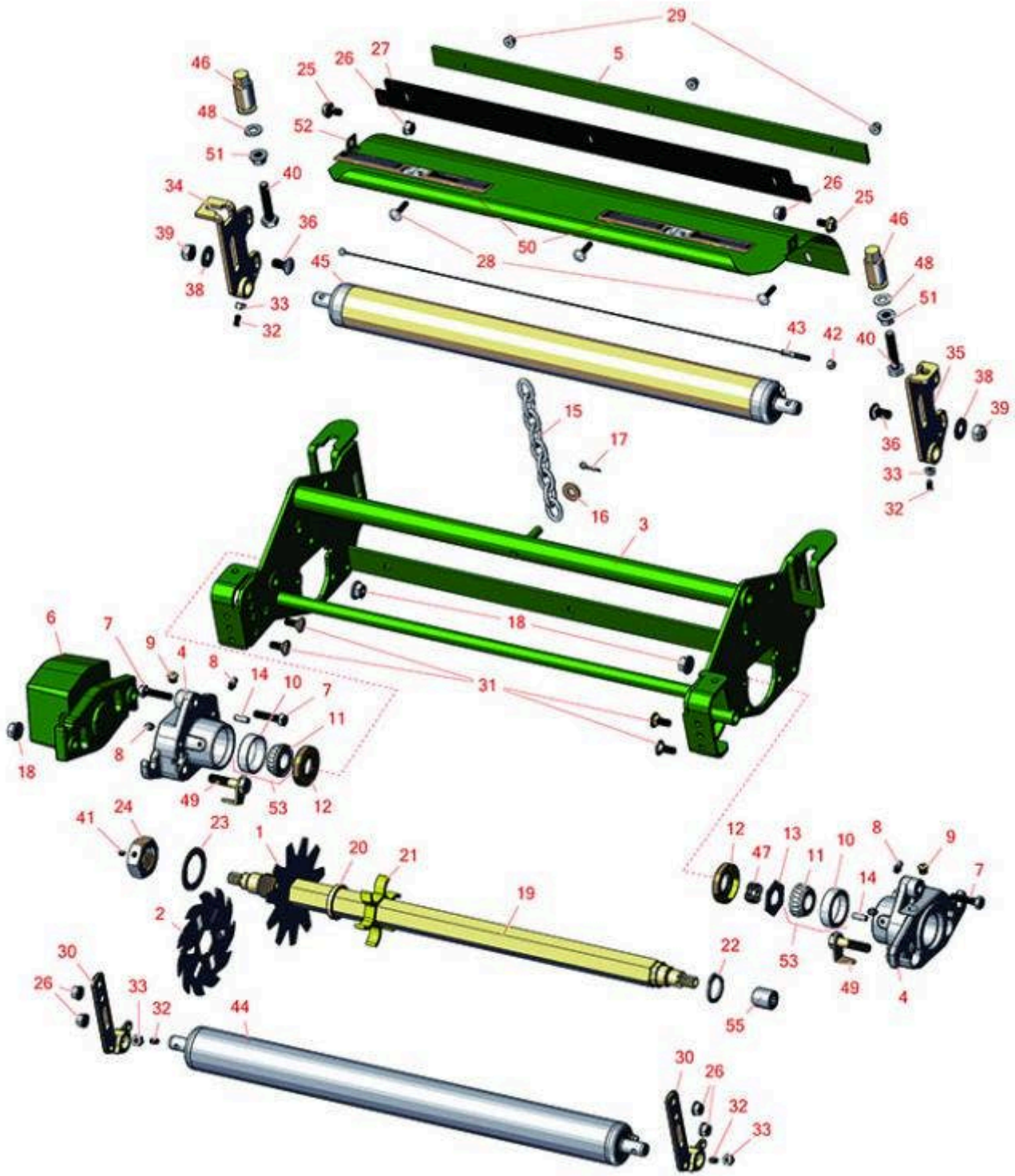

All original equipment manufacturers names and part numbers are used for identification purposes only, and we are in no way implying that our products are original equipment parts. Prices subject to change without notice.



Replaces John Deere 3225B Reel Mower Parts

Medium Verti-Cut Unit
Verti-Cut Reel & Frame



Item No	R&R Part No.	OEM Part No.	Description	Qty Req	Order Quantity
1	RAMT2703	AMT2703, ET17719	Blade - Vertical Mower	27	
2	R150209C	TCU26776	Verti-Cut Blade - Carbide Tipped 2mm	27	
3	RAMT2574	AMT2574	Frame - Verticut	1	
4	RMT7294	MT2647, MT7294	Housing - Reel	2	
5	RAMT2704	AMT2704, MT169	Strap - Verticut Shield	1	
6	RMT6476	MT6476	Counterweight	1	
7	R19M8008	19M8008	Bolt - Hex HD M8-1.25 x 35	6	
8	R302-5	JD7797, JD7842, JD7844	Fitting - Grease	4	
9	R170714	E14814	Fitting - Pressure Relief	2	
10	R254-79	JD8226	Cup - Bearing	2	
<i>Tech Note: Use R254-79M installation mandrel to properly install race.:</i>					
11	R254-78	JD8188	Tapered Bearing Cone	2	
12	RET14566	ET14566	Seal - Reel	2	
13	RET16704	ET16704	Retainer	1	
14	RR30587	30587, R30587	Pin - Dowell 1/4 Dia. x .75	2	
15	RAMT1479	AMT1479	Chain - Link	1	
16	R24H1682	24H1682	Washer - 13/32 x 7/8 x 1/8	1	
17	R11M7012	11M7012	Pin - Cotter 1/8 x 5/8	1	

All original equipment manufacturers names and part numbers are used for identification purposes only, and we are in no way implying that our products are original equipment parts. Prices subject to change without notice.



Replaces John Deere 3225B Reel Mower Parts

Medium Verti-Cut Unit
Verti-Cut Reel & Frame



Item No	R&R Part No.	OEM Part No.	Description	Qty Req	Order Quantity
18	RH135891	H135891	Locknut - 10mm x 1.5 Flanged 10.9	6	
<i>Tech Note: High Strength:</i>					
19	RET17715	ET17715	Shaft - Vertical Mower	1	
20	RET17713	ET17713	Spacer - Vertical Mower Shaft	81	
21	R150230		Spacer - 1/2 Ventilated V-Cut	26	
22	RC17964	C17964	Ring - Retaining HD	1	
23	R24H1513	24H1513	Washer	1	
24	RET17053	ET17053	Nut - 1-1/8-7 Jam Incl Set Screw	1	
25	R19M7865	19M7865	Bolt - Hex Washer M8 x 16	2	
26	R14M7298	14M7298	Nut - 8mm x 1.25 Flanged	6	
27	RET17914	ET17914	Rubber Isolator - Verticut	1	
28	R03M7232	03M7232	Bolt - Carriage M6-1.0 x 25	3	
29	R14M7397	14M7397, 14M7463	Locknut - 6mm x 1.0 ESNA Flanged	3	
30	RMT3015	MT3015	Bracket - RH - Extended	2	
31	R03M7184	03M7184	Bolt - Carriage M8	4	
32	R22H1004	19H3003	Screw - Set 1/4-28 x 1/2	4	
33	R3219-1	14H860	Nut - 1/4-28	4	
34	RAMT5112	AMT5112	Bracket - Roller RH Rear	1	
35	RAMT5113	AMT5113	Bracket - Roller LH Rear	1	
36	R03M7307	03M7307	Bolt - Carriage M10	2	
38	R24H1307	24H1307	Washer - Flat 13/32 x 1 x 1/16	2	

All original equipment manufacturers names and part numbers are used for identification purposes only, and we are in no way implying that our products are original equipment parts. Prices subject to change without notice.



Replaces John Deere 3225B Reel Mower Parts

Medium Verti-Cut Unit
Verti-Cut Reel & Frame



Item No	R&R Part No.	OEM Part No.	Description	Qty Req	Order Quantity
39	R14M7517	14M7517	Locknut - 10mm x 1.5 ESNA	2	
40	R19M7383	19M7383	Bolt - Rear Roller Adj 55 mm Long	2	
41	R3245-35	22H841	Screw - Set 1/4-28 x 1/4	1	
42	RU45916	14M7298, U45916	Locknut - 10-24 ESNA	1	
43	RAET10139	AET10139	Cable - Roller Scraper	1	
44	RAET10111	AET10111, AMT2876	Roller - Smooth Tubular Steel	1	
<i>Tech Note: This tubular steel roller uses greasable "water-pump" style bearings.:</i>					
45	RAMT1060	AMT1060	Roller - Smooth Tubular Steel	1	
<i>Tech Note: This tubular steel roller uses greasable "water-pump" style bearings.:</i>					
46	RMT6483	MT6483	Nut - Adjusting Rear Roller	2	
47	RET14592	ET14592	Spring - Reel Bearing	1	
48	R453011	24M7096	Washer - Flat 3/8 SAE Y/Zinc	2	
49	RAMT2261	AMT2261	Kit - Bolt w/Clip	2	
50	RMT6517	MT6517	Label - Warning	2	
51	R14M7296	14M7296	Nut - 10mm x 1.5 Flanged	2	
52	RAMT2608	AMT2608	Shield - Verticut	1	
53	R500534		Bearing - with Cup	2	
55	RAET11038	AET11038, AET11039, AT11038	Coupler - V-Cut 8 Tooth	1	

All original equipment manufacturers names and part numbers are used for identification purposes only, and we are in no way implying that our products are original equipment parts. Prices subject to change without notice.