

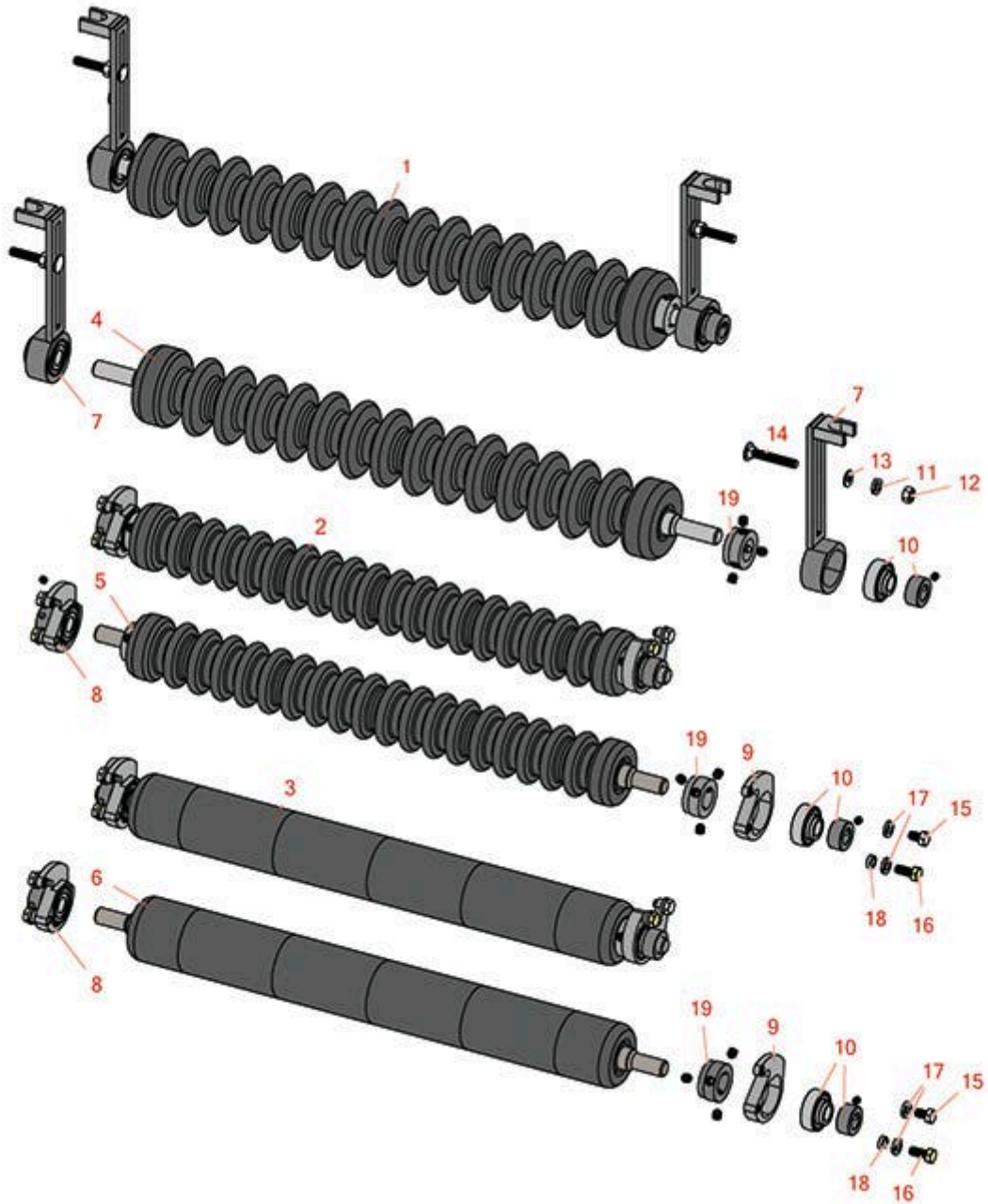

Replaces Jacobsen LF-135 Parts

5" Reel Units

Minuteman Roller System



All original equipment manufacturers names and part numbers are used for identification purposes only, and we are in no way implying that our products are original equipment parts. Prices subject to change without notice.



Replaces Jacobsen LF-135 Parts

5" Reel Units

Minuteman Roller System



Item R&R
No Part No.

OEM
Part No.

Description

Qty
Req

Order
Quantity

Complete Minuteman Roller Systems

1	RMJ3001		Minuteman Front Grooved Roller System	0
---	----------------	--	---------------------------------------	---

Tech Note: Complete roller systems include roller, two brackets with bearings and mounting hardware.:

2	RMJ3002		Minuteman Rear Grooved Roller System	0
---	----------------	--	--------------------------------------	---

Tech Note: Complete roller systems include roller, two brackets with bearings and mounting hardware.:

3	RMJ3003		Minuteman Rear Smooth Roller System	0
---	----------------	--	-------------------------------------	---

Tech Note: Complete roller systems include roller, two brackets with bearings and mounting hardware.:

Minuteman Rollers Only

4	RM528		Minuteman Grooved Roller Only	0
---	--------------	--	-------------------------------	---

Tech Note: Use with Minuteman Roller Bracket System Only:

5	RM515		Minuteman Grooved Roller Only	0
---	--------------	--	-------------------------------	---

Tech Note: Use with Minuteman Roller Bracket System Only:

6	RM516		Minuteman Smooth Roller Only	0
---	--------------	--	------------------------------	---

Tech Note: Use with Minuteman Rollers Bracket System Only:

Other Parts Available

7	RJ121		Bracket - Front LH/RH	0
---	--------------	--	-----------------------	---

8	RJ131		Bracket - Rear LH	0
---	--------------	--	-------------------	---

9	RJ132		Bracket - Rear RH	0
---	--------------	--	-------------------	---

10	RMMB157		Bearing w/Locking Collar	0
----	----------------	--	--------------------------	---

11	R120177	120177	Washer - Lock 3/8	0
----	----------------	--------	-------------------	---

All original equipment manufacturers names and part numbers are used for identification purposes only, and we are in no way implying that our products are original equipment parts. Prices subject to change without notice.



Replaces Jacobsen LF-135 Parts

5" Reel Units

Minuteman Roller System



Item No	R&R Part No.	OEM Part No.	Description	Qty Req	Order Quantity
12	R443110	306562, 443110, 444762	Nut - 3/8-16 Hex	0	
13	R453009	3256-23, 452004, 452006, 452008, 453009	Washer - Flat 5/16 SAE	0	
14	RMM604		Bolt - Carriage 3/8-16 x 2 Gr 5	0	
15	R322-1		Bolt - Hex HD 5/16-18 x 1/2	0	
16	R322-3		Bolt - Hex HD 5/16-18 x 3/4	0	
17	R446136	446134, 446136	Washer - Lock 5/16 Zinc	0	
18	RMM609		Bushing - Aluminum Spacer	0	
19	RMM3		End Hub - 7/8 ID	0	

All original equipment manufacturers names and part numbers are used for identification purposes only, and we are in no way implying that our products are original equipment parts. Prices subject to change without notice.